



FLAT 100
HS PANORAMIC 330

 **LOKVE**[®]
PREMIUM WINDOWS



SADRŽAJ

DIZAJN I KARAKTERISTIKE	01
POZORNOST NA DETALJIMA	03
TEHNIČKI PRESJECI	05
PRIMJERI UGRADNJE	07
KLIZNA STIJENA HS 330 PANORAMIC	09
TEHNIČKI PRESJEK	11
IZBOR BOJA	13
DODATNA OPREMA	15
REFERENCE	17

DIZAJN I KARAKTERISTIKE



KARAKTERISTIKE	FLAT 100	TEHNIČKE KARAKTERISTIKE	FLAT 100
TOPLINSKA IZOLACIJA U_w	0,79 W/m ² K	DEBLJINA PROFILA	105 mm
TOPLINSKA IZOLACIJA STAKLA U_g	0,5 W/m ² K	UGRADBENA DEBLJINA	85 mm
ZVUČNA IZOLACIJA R_w	do 47 dB	ŠIRINA KRILA IZNUTRA	78 mm
SIGURNOST	do RC2	VIDLJIVA ŠIRINA KRILA IZVANA	25 mm
OKOV	VIDLJIVI ILI SKRIVENI	TEŽINA KRILA	do 150 kg



Drvo aluminij prozori danas predstavljaju prozore najviše kvalitete i dizajna. Savršeni spoj drva iznutra koji interijer čini ugodnim i toplim, te aluminija izvana koji eksterijer čini izuzetno modernim, izdržljivim i dugovječnim.

Drvo alu prozori WinAlulok Flat 100, s pravokutnom formom krila iznutra i potpuno poravnatom linijom aluminija izvana, savršeno se uklapaju u modernu arhitekturu.

POZORNOST NA DETALJIMA



WinAlulok Flat 100 drvo aluminijski prozor predstavlja vrhunski odnos između estetskih i funkcionalnih komponenti.

Idealna debljina profila u kombinaciji sa standardnim troslojnim staklom, osigurava vrhunsku toplinsku izolaciju. Dizajniran u duhu modernog i inovativnog pristupa arhitekturi, maksimalno smo posvetili pozornost detaljima.



Potpuno poravnata linija aluminijske izvana, savršeno se uklapa u modernu arhitekturu.



Pravokutna forma krila iznutra, bez letvice za ostakljivanje, koja se uklapa u moderni ambijent.

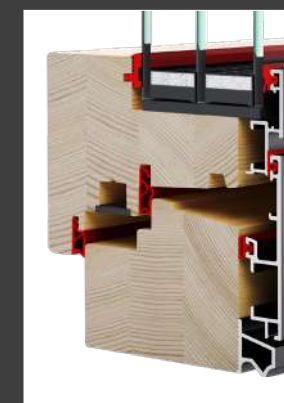

Šesterostruke brtve osiguravaju visoku toplinsku i zvučnu izolaciju.



Troslojno izolacijsko staklo s novom generacijom ostakljivanja s brtvama.



Niski aluminijski termo izolirajući prag visokih performansi.



Izbor između skrivenog ili vidljivog okova opcija su prilikom dizajniranja interijera.

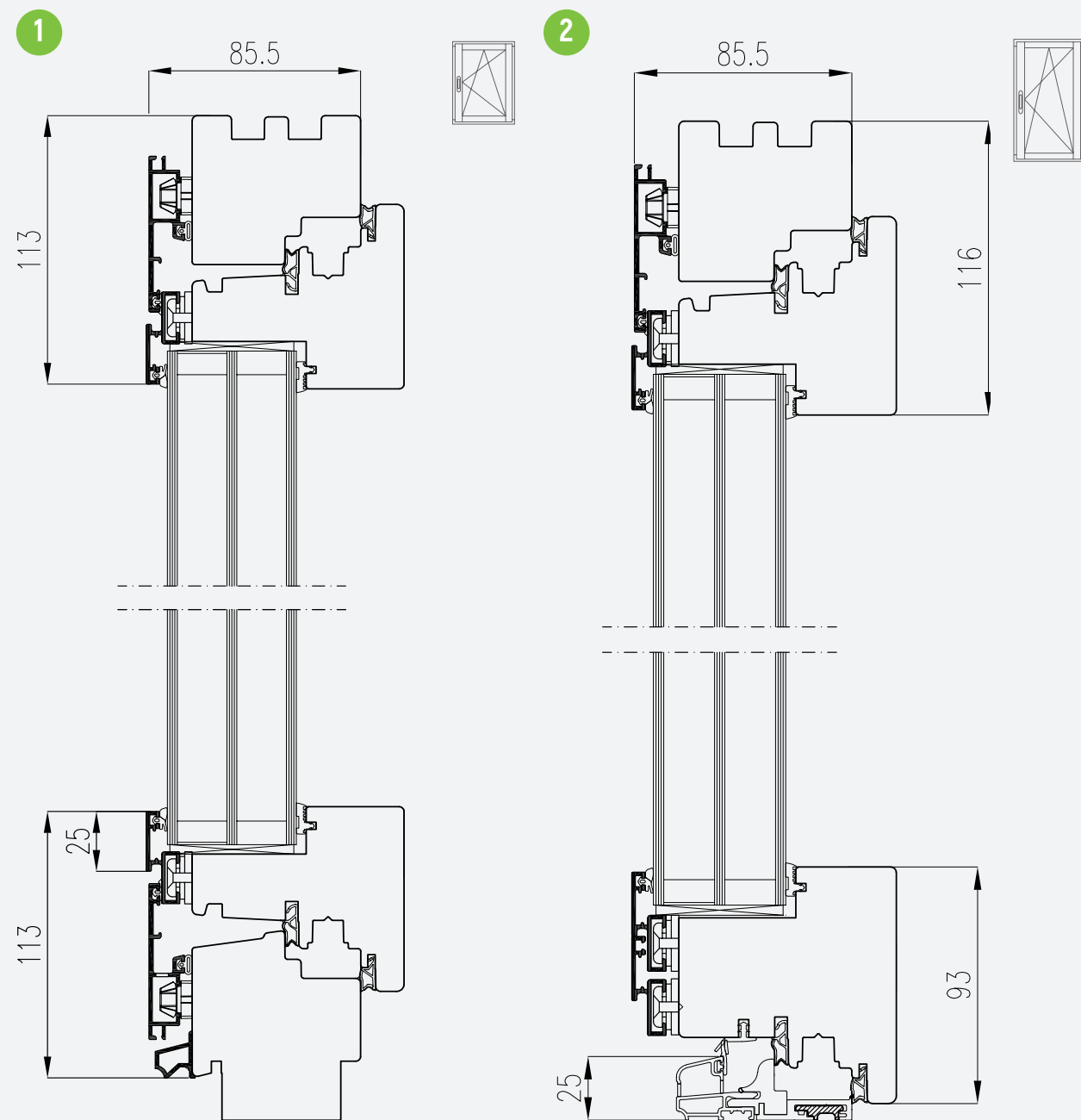

VERTIKALNI PRESJEK:

1. PROZOR

Donji komad sa utorom za unutarnju i vanjsku klupčicu

2. BALKONSKA VRATA

S niskim aluminijskim pragom

TEHNIČKI PRESJECI

CERTIFIKATI	FLAT 100
PROPUSNOST ZRAKA	CLASS 4
VODOTIJESNOST	CLASS E1500
OPTEREĆENJE NA VJETAR	CLASS C5

HORIZONTALNI PRESJEK:

1. DVOKRILNI PROZOR

2. PROZOR S FIKSEROM

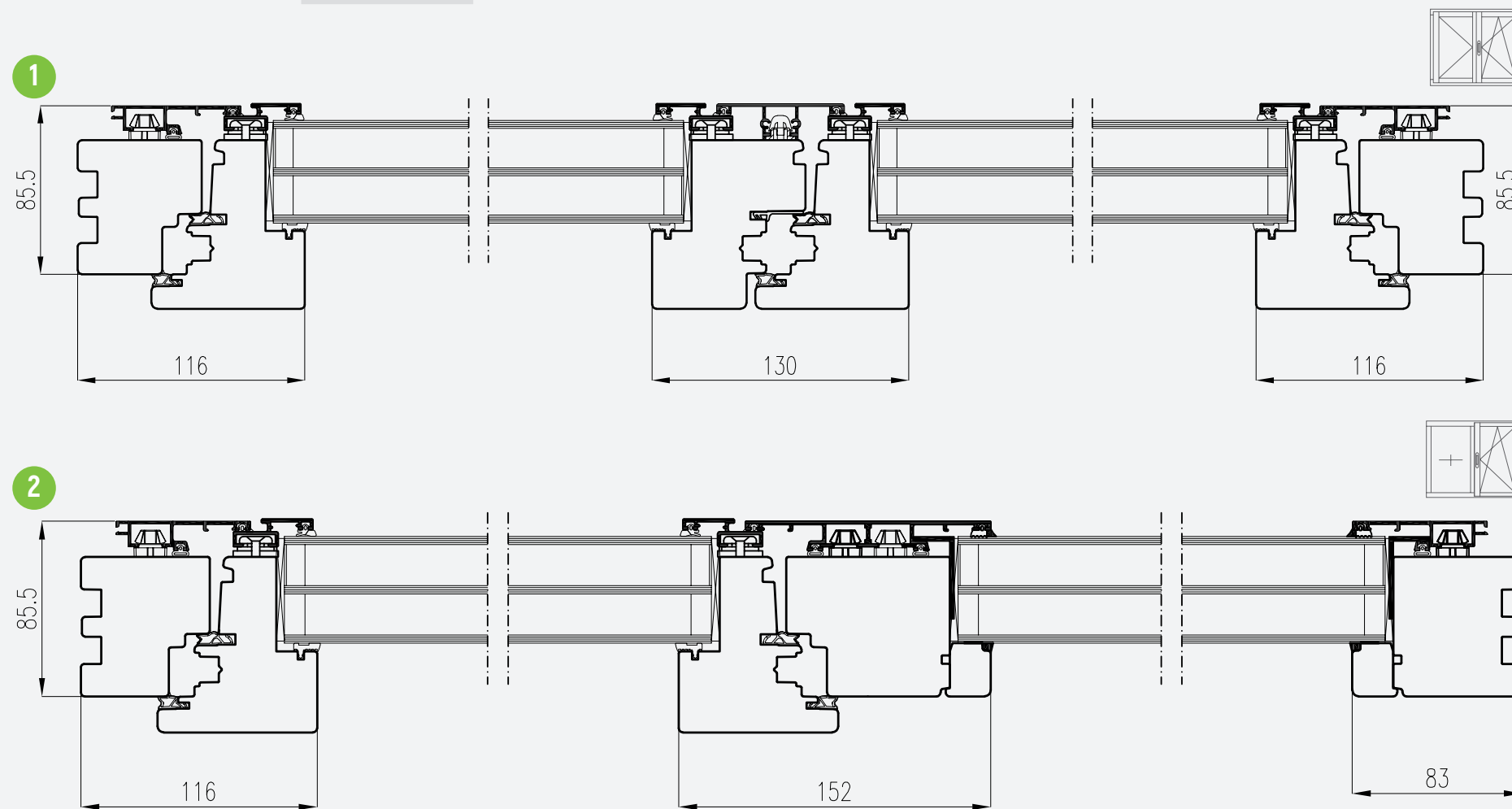

PRIMJERI UGRADNJE

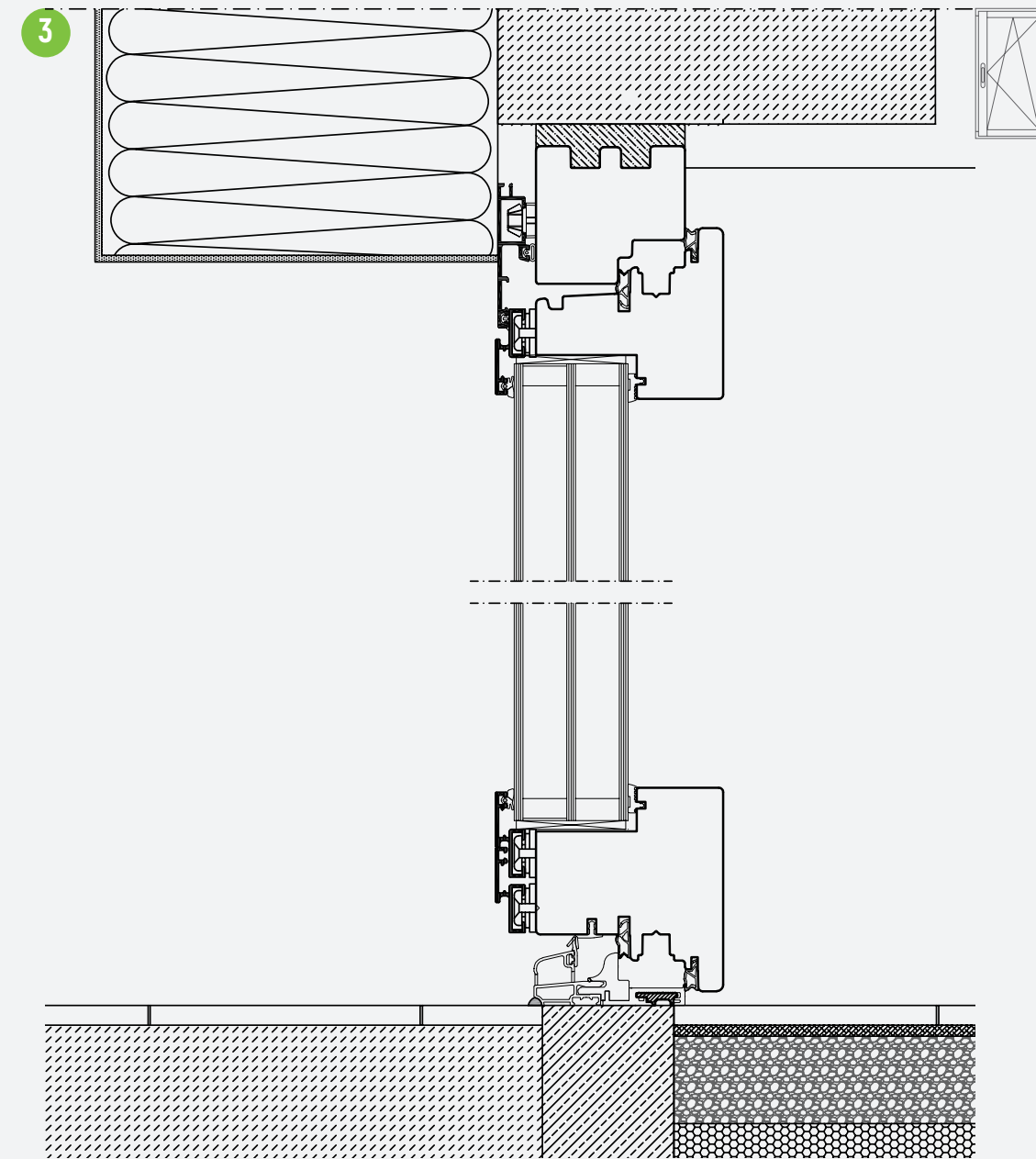
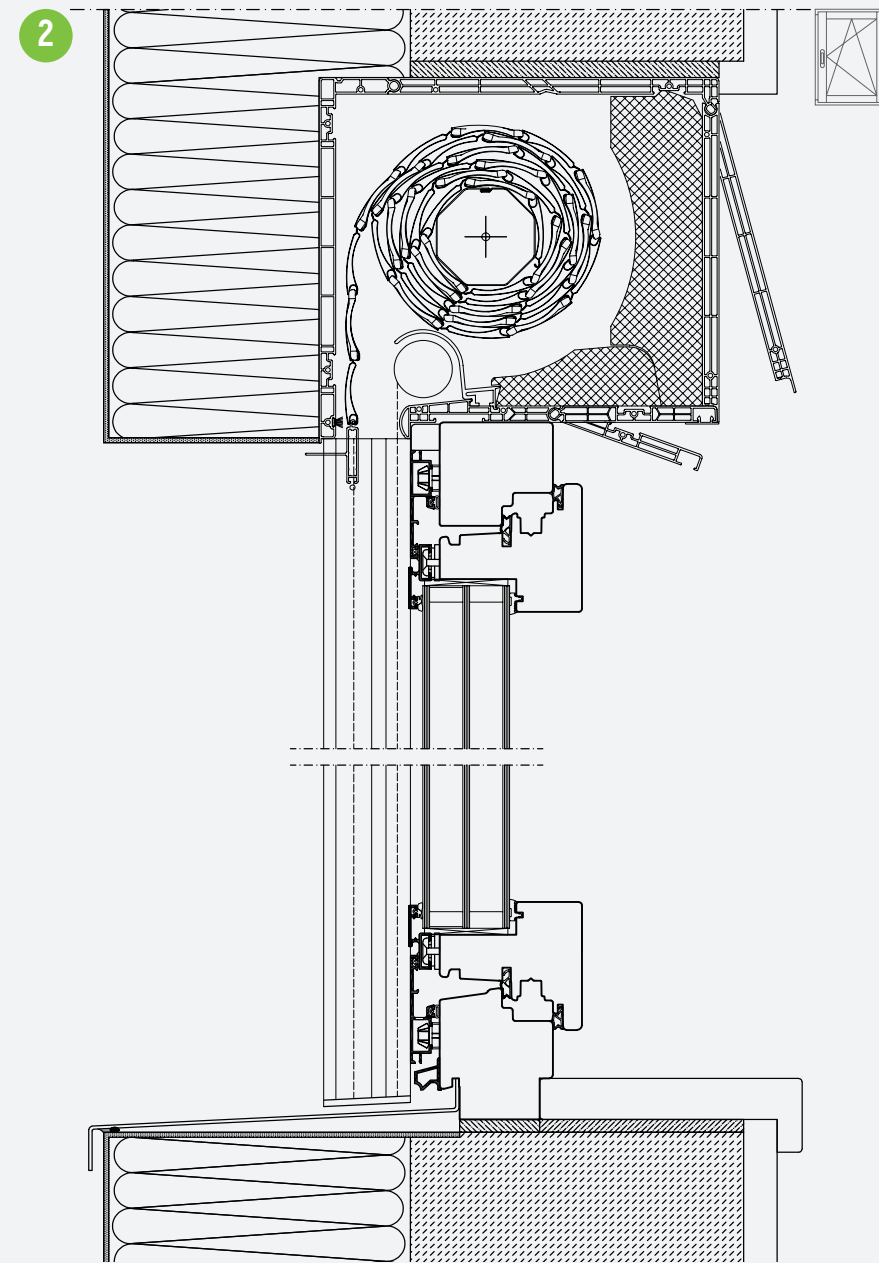
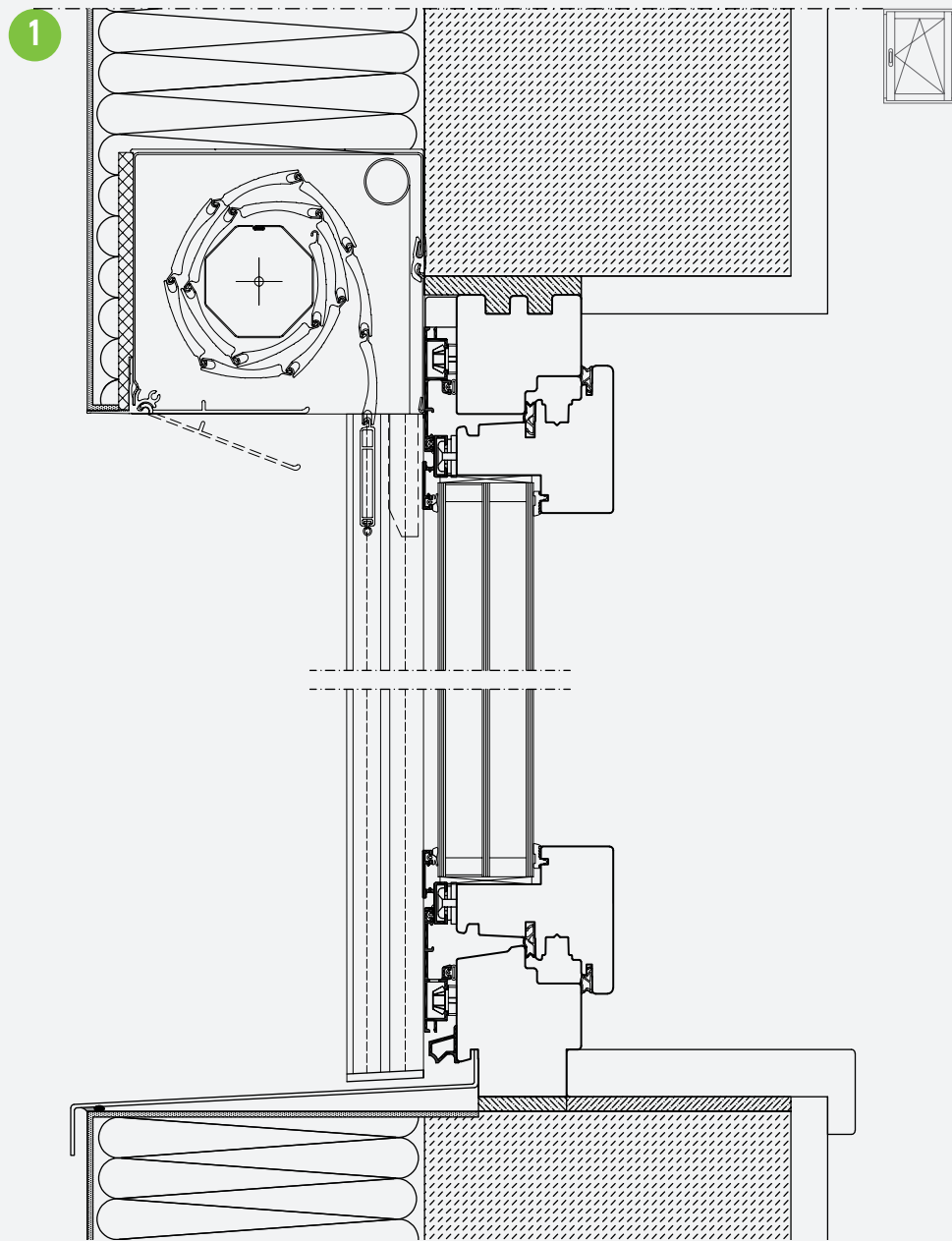

1. PROZOR

S predprozorskom roletom

2. PROZOR

S nadprozorskom roletom

3. BALKONSKA VRATA

S niskim pragom

KLIZNA STIJENA HS 330 PANORAMIC



KARAKTERISTIKE	HS 330 PANORAMIC	TEHNIČKE KARAKTERISTIKE	HS 330 PANORAMIC
TOPLINSKA IZOLACIJA U_w	0,87 W/m ² K	DEBLJINA PROFILA	78 mm
TOPLINSKA IZOLACIJA STAKLA U_g	0,5 W/m ² K	UGRADBENA DEBLJINA	197 mm
ZVUČNA IZOLACIJA R_w	do 47 dB	ŠIRINA KRILA	100 mm
PRAG	Niski termo fiberglass composite	TEŽINA KRILA	do 400 kg



Klizna stijena bez okvira stvara doživljaj potpune otvorenosti koji daje vašem prostoru još više svjetla i dodira sa prirodom iako su vaša vrata zatvorena. Bezokvirni izgled u kombinaciji sa potpunom staklenom površinom u fiksnom dijelu interijer ostavlja bez daha.

Prag u ravnini sa podom omogućuje nesmetan prolaz između interijera i eksterijera. Panoramic stijena s termo pragom od inovativnog materijala Fiberglass Composite osigurava maksimalnu čvrstoću, izolaciju i barijeru protiv vode, vjetra i zraka.

TEHNIČKI PRESJEK

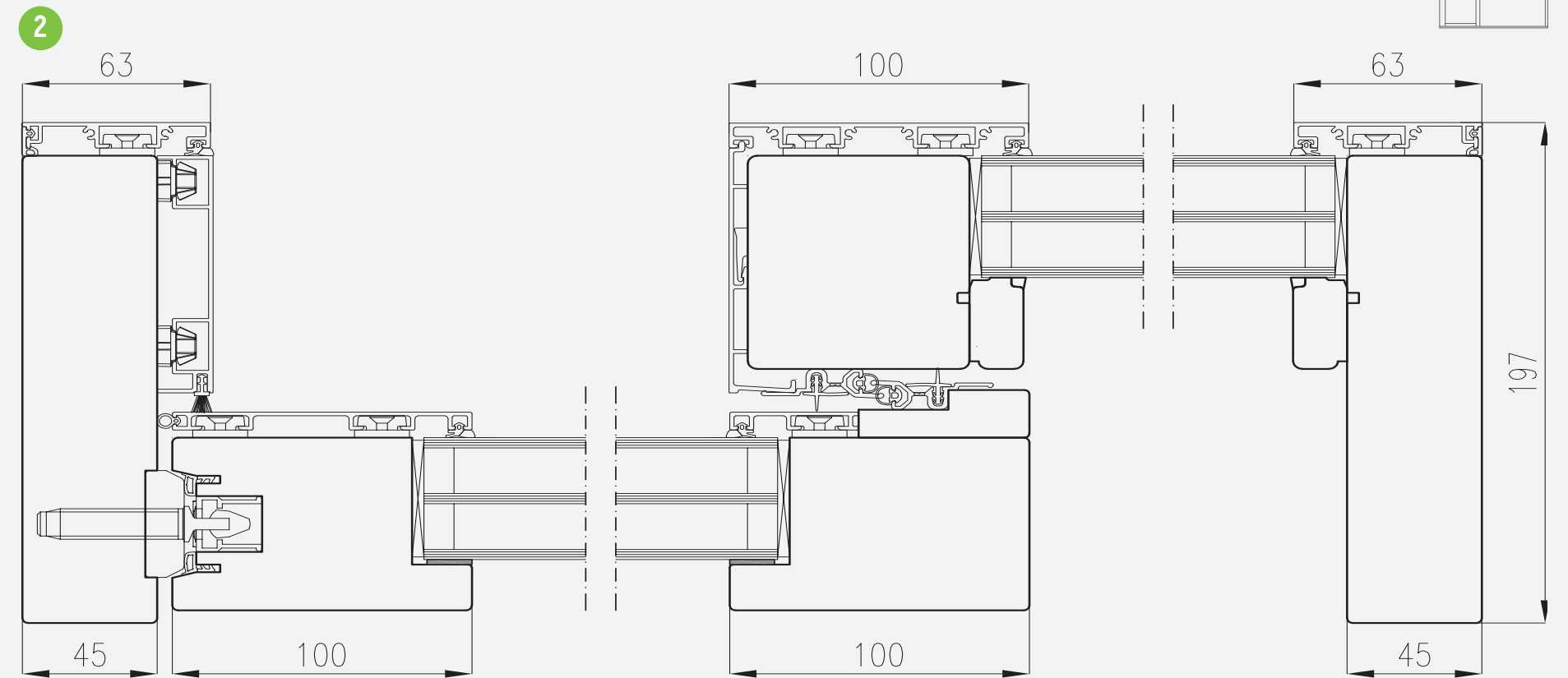
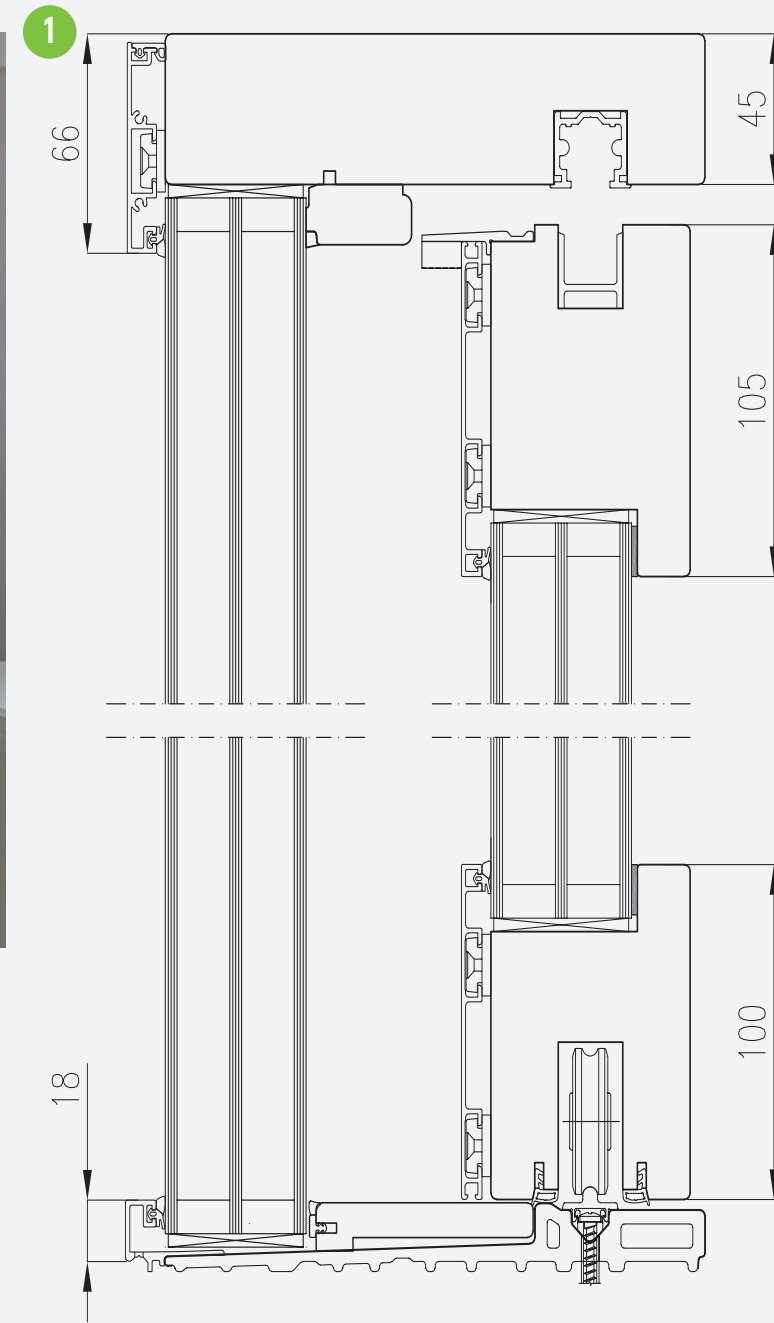

HS 330 PANORAMIC:







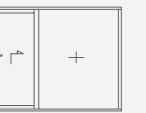



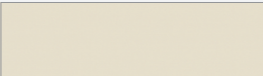









1. VERTIKALNI PRESJEK

2. HORIZONTALNI PRESJEK

Fiksni i klizni dio sa pragom u razini poda

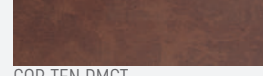

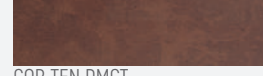













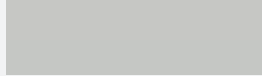
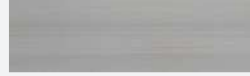

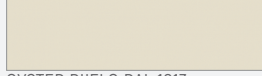
RAL KOLEKCIJA	MAREZZATO KOLEKCIJA	DEKOR KOLEKCIJA
 OYSTER BIJELO RAL 1013	 ZELENA RAL 6005	 BIJELA MAREZZATO M 210
 BIJELA RAL 9010	 SMEĐA RAL 8017	 BIJELI ARIŠ DRL1
 SVIJETLO SIVA RAL 7035	 SEPIA SMEĐA RAL 8014	 DOUGLAS D3D1
 BIJELI ALUMINIJ RAL 9006	 SIVO SMEĐA RAL 8019	 ZLATNI HRAST DR11
 SIVI ALUMINIJ RAL 9007	 BAZALTNO SIVA RAL 7012	 ARIŠ DRL3
 ANTRACIT SIVA RAL 7016		 COR-TEN DMCT
 CRNA RAL 9005	 SIVA ANTICO AN 010	 ORAH S1/R
	 SIVA DB DB 703	 TAMNI ORAH D3F5

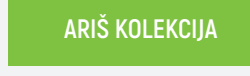
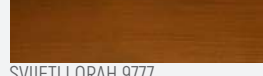
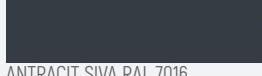
Ton karta aluminija

Uz odabranu boju drva u interijeru, nudimo i veliki izbor boja aluminijskih okvira koji udovoljavaju zahtjevu svakog eksterijera. Aluminijski okvir s vanjske strane dodatna je zaštita drvenog prozora od nepovoljnih vremenskih utjecaja, a povrh svega, moderan je.

IZBOR BOJA

CLASSIC KOLEKCIJA	RAL KOLEKCIJA	NATIVA MATT KOLEKCIJA
 BEZBOJNO* E 701	 BIJELO RAL 9010	 NATIVA NATUR* NL 0904
 JELA E 9802	 SVIJETLO SIVA RAL 7035	 NATIVA BIJELA* NS 0907
 OKER JASEN E 0277	 OYSTER BIJELO RAL 1013	
 ZLATNI HRAST S020	 GOLUBINJE PLAVO RAL 5014	
 SVIJETLI ORAH 9777	 ANTRACIT SIVA RAL 7016	 ARIŠ ULJENI ULJE
 TAMNI ORAH E 707	 TAMNO ZELENA RAL 6005	 BEZBOJNO (ARIŠ)* E 701
 LJEŠNJAK H 3614	 SEPIA SMEĐA RAL 8014	

Ton karta drva

Lokve proizvodi zaštićeni su od grubih vanjskih utjecaja visokokvalitetnim akrilnim bojama na vodenim bazama. Automatskim robotskim lakiranjem postizemo potpunu zaštitu drva i visoku kvalitetu završnog laka. Ton karta pruža vam mogućnost odabira pokrivnih RAL boja, transparentnih boja s vidljivom strukturom drva ili inovativne transparente boje s "metalik ili full matt efektom".

DODATNA OPREMA



Sva dodatna oprema

- Rolete, vanjske žaluzine, Zip screen
- Drvene i aluminijske šture i grilje
- Komarnici
- Prozorske klupčice
- Poluolive



Predprozorske rolete



Nadprozorske rolete



Zip Screen

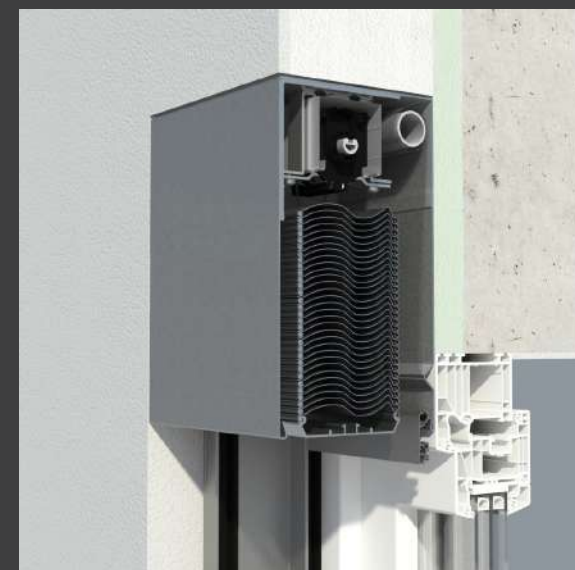

Predprozorska vidljiva žaluzina



Predprozorska podžbukna žaluzina

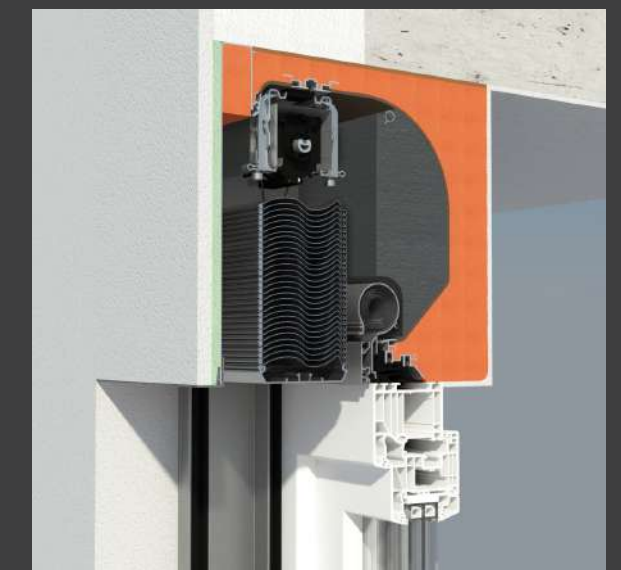

Nadprozorska žaluzina

REFERENCE



Villa Luca
Zadar, Hrvatska



Projekt Alfred Kubin
Salzburg, Austrija



Villa Rabac
Istra, Hrvatska



Lokve d.o.o.
Homer 39
51316 Lokve
Hrvatska

T: +385 51 508 300
E: lokve@lokve.com

